

Owner's Guide
Bedienungsanleitung
Guía del usuario
Notice d'utilisation
Manual do Proprietário
用戶指南

The Bose logo is displayed in a stylized, italicized font with a horizontal line through the middle of the letters.

PROFLIGHT SERIES 2
AVIATION HEADSET

Please read and keep all safety and use instructions.

CE Bose Corporation hereby declares that this product is in compliance with the essential requirements and other relevant provisions of Directive 2014/53/EU and all other applicable EU directive requirements. The complete declaration of conformity can be found at: www.Bose.com/compliance

**UK
CA** This product conforms to all applicable Electromagnetic Compatibility Regulations 2016 and all other applicable UK regulations. The complete declaration of conformity can be found at: www.Bose.com/compliance

Bose Corporation hereby declares that this product is in compliance with the essential requirements per Radio Equipment Regulations 2017 and all other applicable UK regulations. The complete declaration of conformity can be found at: www.Bose.com/compliance

Important Safety Instructions

WARNINGS/CAUTIONS

- Do NOT use the headphones with noise canceling mode at any time the inability to hear surrounding sounds may present a danger to yourself or others, e.g., while riding a bicycle or walking in or near traffic, a construction site or railroad, etc.
- Keep batteries out of reach of children.
- Please dispose of used batteries properly, following any local regulations.
- Batteries may cause a fire or chemical burn if mishandled. Do not recharge, disassemble, heat, or incinerate.
- When a replacement is needed, use only a AA (LR06) alkaline batteries.

Please read and save this guide

Please read this guide carefully. Save this guide for future reference and make it easily accessible for passengers and third parties who use this headset.

- **Switch to an alternate communications method in the event of a headset issue.**

In the unlikely event of any headset issue or failure in the passive noise reducing mode, switch to an alternate communications method and use standard cockpit resource management skills to minimize distractions.

- **Use the headset at a moderate volume level.**

To avoid hearing damage, use the headset at a comfortable, moderate volume level. Limit the headset volume to safe levels that do not interfere with your ability to hear informational sounds and warning alarms, such as stall warnings or gear up, while piloting.

- **Turn the headset off if it emits any loud noise.**

As with any complex electronic device, it is possible for this headset to fail during operation. Symptoms of failure, which may include loud tones, distortion, feedback squeals and loss of communications signal in the headset, can occur in either the Acoustic Noise Cancelling mode (turned on) or in the passive mode (turned off). If the headset emits any loud noise and the related loss of communications in the Acoustic Noise Cancelling mode, turn off the power switch. The headset will continue to provide communications in the passive noise-reducing mode. If the problem persists, see "Troubleshooting" on page 48.

- **Be aware of sound differences while wearing the headset.**

With the headset's active and passive noise reduction, typical aircraft sounds (such as engines, propellers, warning alarms, and other sound sources) may not sound familiar. Make sure you can hear and recognize these sounds when using the headset while operating any aircraft.

- **Do NOT make phone calls while piloting.**

Do not use the headset for telephone calls during flight operations.

- **Make sure your aircraft communications system volume control is easily accessible.**

This control affects the strength of the communications signal coming into the headset. Make sure you can understand critical communications even with Acoustic Noise Cancelling mode turned off. In this case, you may need to turn up the aircraft communications system volume. In passive mode, the volume controls on the control module will automatically be set to maximum volume. For additional volume control, use the intercom or radio volume control. If your headset is aircraft powered, connect the headset to the aircraft power sources only as described in “Aircraft Connectors” on page 30.

- **Make sure portable devices do not interfere with the aircraft’s navigation and communication systems. Reference FAA AC 91.21-1D, or later revision, for installation approval.**

It is the pilot’s responsibility to ensure that portable devices do not interfere with the aircraft’s navigation and communication systems, as well as to determine if the portable device is suitable for use with the headset.

- **Use only AA alkaline batteries.**

To avoid risk of explosion, replace the batteries only with AA alkaline batteries. Properly dispose of used batteries.

- **Do NOT repair the headset yourself.**

Contact the Bose organization in your country/region for specific care, return and shipping instructions. Visit: global.Bose.com

- **Do not use the headset with a helmet or as part of a crash protection system.**

The headset is not intended for such use, and has not been certified for crash protection. Dismantling, reassembly or modification of the headset, or any part, for use in a helmet or other crash protection system could result in severe bodily injury and such unauthorized use will void the limited product warranty.

- **Do NOT immerse the headset or any parts in water or any other liquid.**

See “Clean the headset” on page 42 for cleaning instructions.



Contains small parts which may be a choking hazard. Not suitable for children under age 3.



This product contains magnetic material. Consult your physician on whether this might affect your implantable medical device.

- Do NOT expose this product to dripping or splashing, and do not place objects filled with liquids, such as vases, on or near the product.
- Do NOT make unauthorized alterations to this product.
- The battery provided with this product may present a risk of fire, explosion or chemical burn if mishandled, incorrectly replaced or replaced with an incorrect type.
- Do not expose products containing batteries to excessive heat (e.g. from storage in direct sunlight, fire or the like).

NOTE:

This equipment has been tested and found to comply with the limits for a Class B digital device, pursuant to Part 15 of the FCC Rules. These limits are designed to provide reasonable protection against harmful interference in a residential installation. This equipment generates, uses, and can radiate radio frequency energy and, if not installed and used in accordance with the instructions, may cause harmful interference to radio communications. However, there is no guarantee that interference will not occur in a particular installation. If this equipment does cause harmful interference to radio or television reception, which can be determined by turning the equipment off and on, the user is encouraged to try to correct the interference by one or more of the following measures:

- Reorient or relocate the receiving antenna.
- Increase the separation between the equipment and receiver.
- Connect the equipment into an outlet on a circuit different from that to which the receiver is connected.
- Consult the dealer or an experienced radio/TV technician for help.

Changes or modifications not expressly approved by Bose Corporation could void the user's authority to operate this equipment.

This device complies with part 15 of the FCC Rules and with Industry Canada license-exempt RSS standard(s). Operation is subject to the following two conditions: (1) This device may not cause harmful interference, and (2) this device must accept any interference received, including interference that may cause undesired operation.

This device complies with FCC and Industry Canada radiation exposure limits set forth for general population. This transmitter must not be co-located or operating in conjunction with any other antenna or transmitter.

CAN ICES-3(B)/NMB-3(B)**For Europe:****Frequency band of operation 2400 to 2483.5 MHz:**

- *Bluetooth*: Maximum transmit power less than 20 dBm EIRP.
- *Bluetooth Low Energy*: Maximum power spectral density less than 10 dBm/MHz EIRP.



This symbol means the product must not be discarded as household waste, and should be delivered to an appropriate collection facility for recycling. Proper disposal and recycling helps protect natural resources, human health and the environment. For more information on disposal and recycling of this product, contact your local municipality, disposal service, or the shop where you bought this product.



Please dispose of used batteries properly, following local regulations. Do not incinerate.

**Management Regulation for Low-power Radio-frequency Devices****Article XII**

According to "Management Regulation for Low-power Radio-frequency Devices" without permission granted by the NCC, any company, enterprise, or user is not allowed to change frequency, enhance transmitting power or alter original characteristic as well as performance to an approved low power radio-frequency devices.

Article XIV

The low power radio-frequency devices shall not influence aircraft security and interfere legal communications; If found, the user shall cease operating immediately until no interference is achieved. The said legal communications means radio communications operated in compliance with the Telecommunications Act.

The low power radio-frequency devices must be susceptible with the interference from legal communications or ISM radio wave radiated devices.

低功率電波輻射性電機管理辦法

第十二條 經型式認證合格之低功率射頻電機，非經許可，公司、商號或使用者均不得擅自變更頻率、加大功率或變更原設計之特性及功能。

第十四條 低功率射頻電機之使用不得影響飛航安全及干擾合法通信；經發現有干擾現象時，應立即停用，並改善至無干擾時方得繼續使用。

前項合法通信，指依電信規定作業之無線電通信。低功率射頻電機須忍受合法通信或工業、科學及醫療用電波輻射性電機設備之干擾。

China Restriction of Hazardous Substances Table

| Names and Contents of Toxic or Hazardous Substances or Elements | | | | | | |
|---|--|--------------|--------------|---------------------|-------------------------------|---|
| Part Name | Toxic or Hazardous Substances and Elements | | | | | |
| | Lead (Pb) | Mercury (Hg) | Cadmium (Cd) | Hexavalent (CR(VI)) | Polybrominated Biphenyl (PBB) | Polybrominated diphenylether (PBDE) |
| PCBs | X | 0 | 0 | 0 | 0 | 0 |
| Metal Parts | X | 0 | 0 | 0 | 0 | 0 |
| Plastic Parts | 0 | 0 | 0 | 0 | 0 | 0 |
| Speakers | X | 0 | 0 | 0 | 0 | 0 |
| Cables | X | 0 | 0 | 0 | 0 | 0 |
| This table is prepared in accordance with the provisions of SJ/T 11364. O: Indicates that this toxic or hazardous substance contained in all of the homogeneous materials for this part is below the limit requirement of GB/T 26572. X: Indicates that this toxic or hazardous substance contained in at least one of the homogeneous materials used for this part is above the limit requirement of GB/T 26572. | | | | | |  |

Taiwan Restriction of Hazardous Substances Table

| Equipment name: Bose ProFlight Series 2 Aviation Headset, Type designation: 430970 | | | | | | |
|---|--|--------------|--------------|----------------------------|--------------------------------|---------------------------------------|
| Unit | Restricted substances and its chemical symbols | | | | | |
| | Lead (Pb) | Mercury (Hg) | Cadmium (Cd) | Hexavalent chromium (Cr+6) | Polybrominated biphenyls (PBB) | Polybrominated diphenyl ethers (PBDE) |
| PCBs | - | o | o | o | o | o |
| Metal Parts | - | o | o | o | o | o |
| Plastic Parts | o | o | o | o | o | o |
| Speakers | - | o | o | o | o | o |
| Cables | - | o | o | o | o | o |
| Note 1: "o" indicates that the percentage content of the restricted substance does not exceed the percentage of reference value of presence. | | | | | | |
| Note 2: The "-" indicates that the restricted substance corresponds to the exemption. | | | | | | |

Date of Manufacture: The eighth digit in the serial number indicates the year of manufacture; “9” is 2009 or 2019.

China Importer: Bose Electronics (Shanghai) Company Limited, Level 6, Tower D, No. 2337 Gudai Rd. Minhang District, Shanghai 201100

EU Importer: Bose Products B.V., Gorslaan 60, 1441 RG Purmerend, The Netherlands

Taiwan Importer: Bose Taiwan Branch, 9F-A1, No.10, Section 3, Minsheng East Road, Taipei City 104, Taiwan
Phone Number: +886-2-2514 7676

Mexico Importer: Bose de México, S. de R.L. de C.V. , Paseo de las Palmas 405-204, Lomas de Chapultepec, 11000 México, D.F. Phone Number: +5255 (5202) 3545

UK Importer: Bose Limited, Bose House, Quayside Chatham Maritime, Chatham, Kent, ME4 4QZ, United Kingdom

Legal Information

Apple and the Apple logo are trademarks of Apple Inc. registered in the U.S. and other countries. App Store is a service mark of Apple Inc.

Android, Google Play, and the Google Play logo are trademarks of Google LLC.

The *Bluetooth*® word mark and logos are registered trademarks owned by Bluetooth SIG, Inc. and any use of such marks by Bose Corporation is under license.

Bose Corporation Headquarters: 1-877-230-5639

Bose, Acoustic Noise Cancelling, and StayHear are trademarks of Bose Corporation.

©2022 Bose Corporation. No part of this work may be reproduced, modified, distributed or otherwise used without prior written permission.

BOSE CONNECT APP

Features 11

WHAT'S IN THE BOX

Contents 12

Headset components 13

Control module options 14

IMPORTANCE OF PROPER FIT

Fit the headband..... 15

Choose the correct StayHear+ tips..... 16

Fit the earbuds to your ear 16

Single earbud use 17

Change the StayHear+ tips 17

Adjust the microphone..... 18

Conditions related to fit 19

Secure clothing clip and control module holder 19

Clothing clip..... 19

Control module holder 19

HEADSET CONTROLS

Power on 20

Power off..... 20

ACOUSTIC NOISE CANCELLATION

Acoustic Noise Cancelling functions..... 21

Tap Control for talk-through communication..... 22

Reset Tap Control..... 22

OPERATION SWITCHES

Operation switch functions..... 23
 Change the operation switches..... 24

MICROPHONE PLACEMENT

Move the microphone 26

BATTERIES

Replace the batteries 29

AIRCRAFT CONNECTORS

Dual plug 30
 Connect to the aircraft 30
 Disconnect from the aircraft 30
 5-pin XLR, 6-pin Lemo, and 7-pin XLR..... 31
 Connect to the aircraft 31
 Disconnect from the aircraft 31

STATUS LIGHTS

Bluetooth[®] light..... 32
 Power light 33

BLUETOOTH CONNECTIONS

Connect using the *Bluetooth* menu on your mobile device 34
 Connect your mobile device using the Bose Connect app..... 35
Bluetooth audio priority 35
 Disconnect a mobile device..... 36
 Reconnect a mobile device..... 37
 Recover a lost connection..... 37

MANAGING MULTIPLE *BLUETOOTH* CONNECTIONS

Connect an additional mobile device 38

Switch between connected devices..... 38

Clear the headset pairing list 38

***BLUETOOTH* FUNCTIONS**

Bluetooth volume functions 39

Call functions..... 39

CARE AND MAINTENANCE

Store the headset 41

Clean the headset..... 42

Limited warranty 42

Serial number location..... 43

Replacement parts and accessories..... 43

 Side pad cushion..... 43

 Headband cushion 44

 StayHear+ tips 45

 Microphone windscreen..... 45

 Batteries 46

 Microphone or terminator cover..... 46

TROUBLESHOOTING

Try these first..... 47

Other solutions 47

 Acoustic Noise Cancelling..... 47

 Intercom communications..... 48

 Audio 49

 Microphone 50

Bluetooth audio source 51

 Auto on/off..... 52

INSTALLATION

Mount the aircraft panel connector 53

 Mono connection diagram 54

 Stereo connection diagram 55

 Details on making the connections 56

TECHNICAL INFORMATION

FAA Technical Standard Order 58

Enhance your headset experience with the Bose Connect app.

FEATURES

Easily connect to and switch between multiple mobile devices with a single swipe.

Customize your headset experience:

- Name your headset.
- Share audio and music.
- Adjust *Bluetooth* volume.

NOTE: Applies to *Bluetooth* headsets only.

- Find answers to frequently asked questions.



CONTENTS

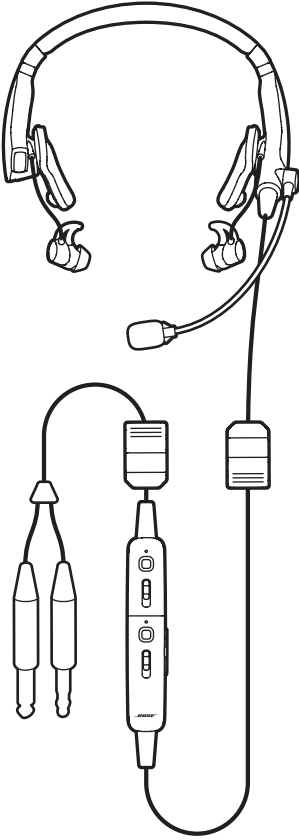

Bose ProFlight Series 2 Aviation Headset



Carry case



Carry case hook



AA batteries (2)



Control module holder

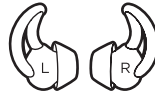

StayHear+ tips:
Large (black) and Small (white)

NOTE: Medium (gray) tips are attached to the earbuds.

NOTES:

- For control module options, see page 14.
- For aircraft connector types, see page 30.
- If any part of the product is damaged, don't use it. Contact your authorized Bose dealer or Bose customer service.

Visit: worldwide.Bose.com/Support/ProFlight2

HEADSET COMPONENTS

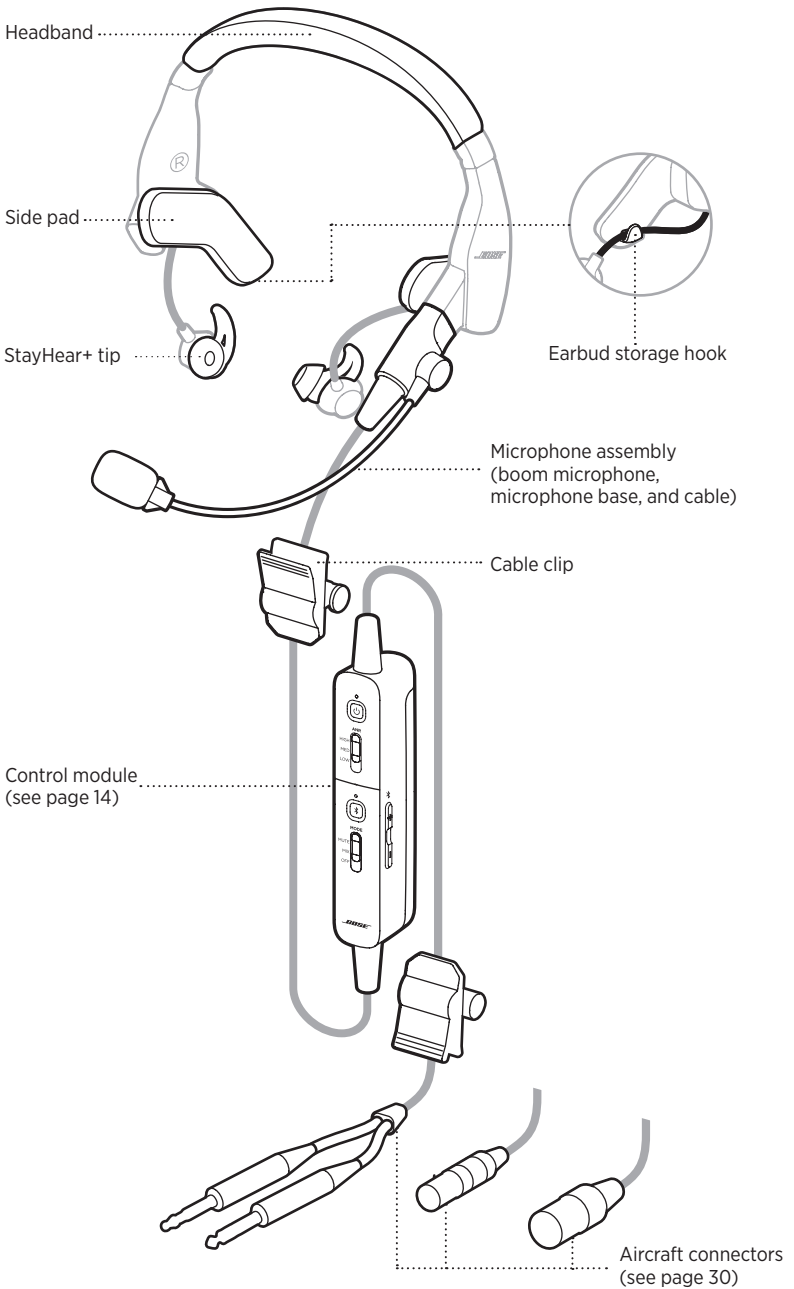

CONTROL MODULE OPTIONS

There are two options for the control module:

- Control module with *Bluetooth* capability
- Conventional control module

Control module with *Bluetooth* capability

Conventional control module

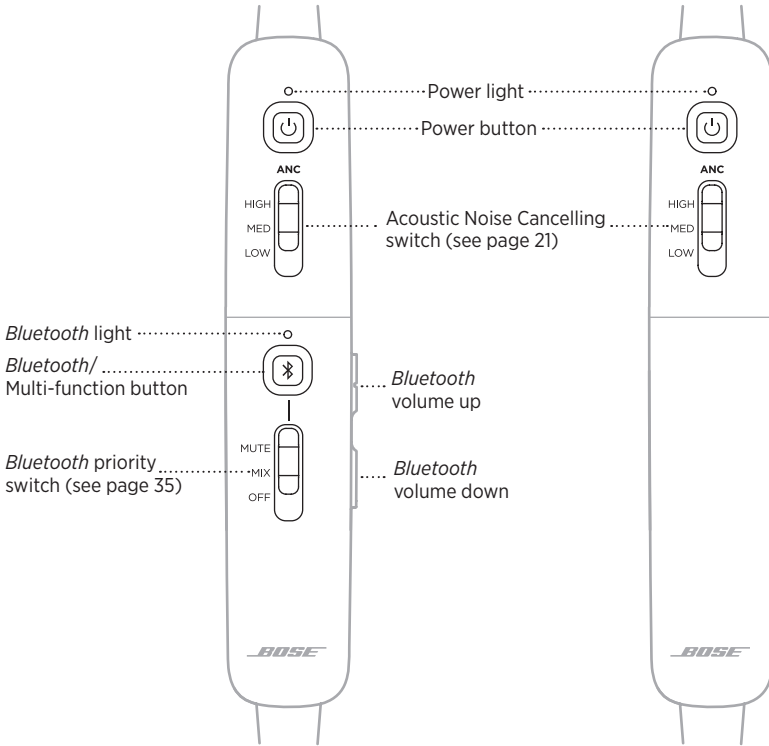

FIT THE HEADBAND

Proper fit is important both for comfort and optimal noise cancellation performance.

1. Using the left (L) and right (R) icons on the headband to orient the headset properly, rotate the side pads into position.

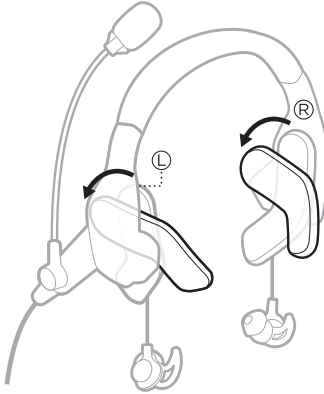

2. Place the headset on your head.
3. Adjust the headband so the side pads rest above your ears.

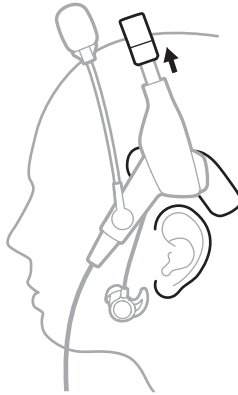

CHOOSE THE CORRECT STAYHEAR+ TIPS

For optimal audio performance, it is important to choose the correct size StayHear+ tip. Select the size that gives you the best comfort and fit in each ear. To determine the best fit, you may need to try all three sizes. You may need a different size for each ear.

NOTE: Without a properly fitting tip, the noise reduction and audio performance of the headset will be degraded. To test the fit, try speaking aloud wearing the headset while it's powered off. Make a low-pitched “eee” sound. Your voice should sound amplified and balanced in both ears, similar to when you plug your ears with your fingers. If not, try another tip size.

Each StayHear+ tip and earbud is marked with either an **L** or an **R**. Be sure to attach the left tip to the left earbud and the right tip to the right earbud.

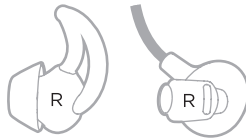

FIT THE EARBUDS TO YOUR EAR

The StayHear+ tip allows the earbud to rest comfortably and securely in your ear. The tip wing fits just under your ear ridge.

1. Insert the earbud so the StayHear+ tip rests gently in the opening of the ear canal.
2. Tilt the earbud back and tuck the tip wing under the ear ridge until it is secure.

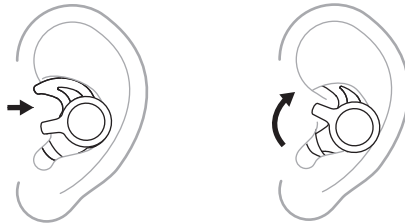

TIP: If the StayHear+ tips don't fit securely, choose a different size.

Single earbud use

When you want to use the headset with one earbud, you can stow the other earbud using the earbud storage hook on the back of the side pad.

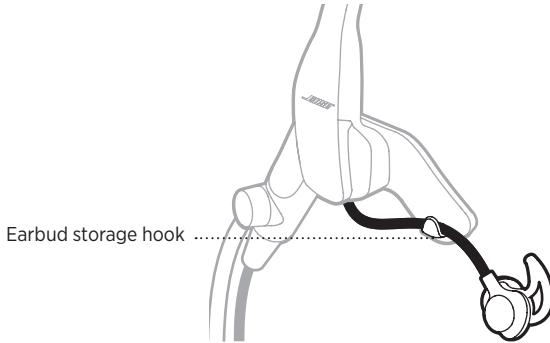

CHANGE THE STAYHEAR+ TIPS

1. Holding the earbud, gently grasp the attached StayHear+ tip and peel it away from the earbud.

CAUTION: To prevent tearing, grasp the StayHear+ tip by its base. Do NOT pull on the tip wing.

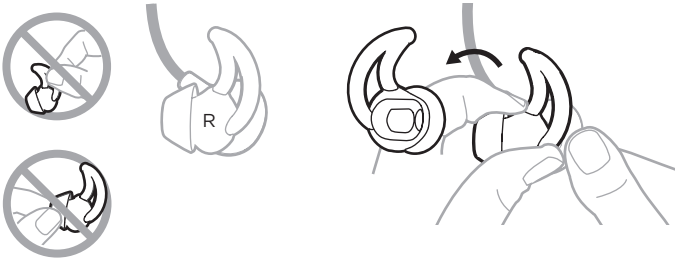

2. Align the opening of the new StayHear+ tip with the earbud nozzle and rotate the tip onto the nozzle. Press the base of the tip until it clicks securely into place.

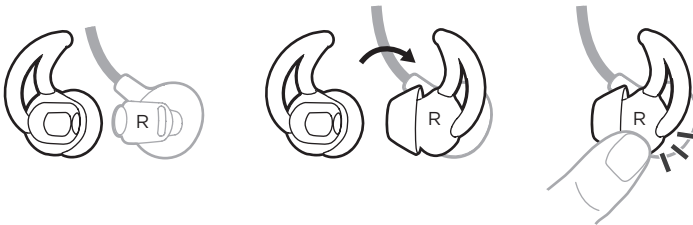

ADJUST THE MICROPHONE

NOTE: By default, the reversible microphone ships from the factory attached to the left side of the headset. If you want to move the microphone to the other side of the headset, see “Microphone Placement” on page 26.

1. Grasp the microphone base, and adjust the boom so the microphone is level with your mouth.

CAUTION: Microphone placement is important for clear communication. It can rotate 300°. Do NOT force the microphone beyond the intended rotation or damage could occur.

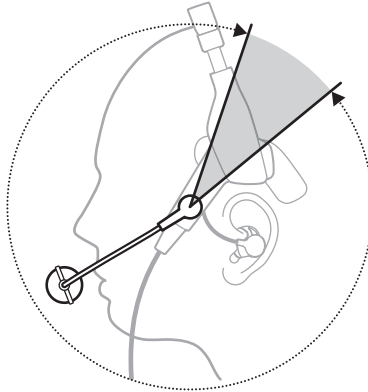

2. Position the microphone so it is 0.5" (12.7 mm) from your lips, and the white surface on the base is facing your mouth.

NOTES:

- If necessary, twist the microphone base to rotate the microphone into position.
- The microphone should not be touching your lips.

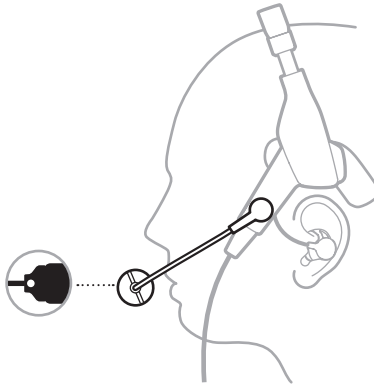

3. Test the headset before flight.

CONDITIONS RELATED TO FIT

In very loud conditions, such as during takeoff, you may experience a brief reduction in noise cancellation as the headset compensates for a momentary pressure change. If this continues when the sound level returns to normal, see “Acoustic Noise Cancellation” on page 21. If it persists, see “Troubleshooting” on page 48.

A low rumbling sound or frequent, brief losses of noise cancellation may indicate an improper fit or blocked earbud ports. See “Choose the correct StayHear+ tips” on page 16 for information on proper fit or “Clean the headset” on page 42 for instructions on removing blockages.

During a long flight, you may feel a slight pressure point, which can be relieved by adjusting the headband position.

SECURE CLOTHING CLIP AND CONTROL MODULE HOLDER

The cable clips and control module holder secure the cable and control module to your clothing, a safety harness, sun visor rail, or aircraft headset hook for quick and easy access.

Clothing clip

Press the side button to release and reposition the clip along the cable.

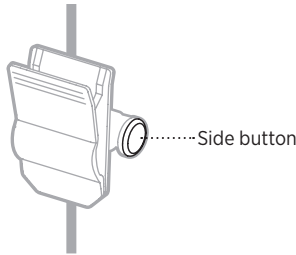

Control module holder

Pull the strap over the control module to secure it in place.

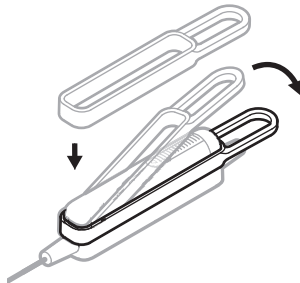

POWER ON

Press the Power button .

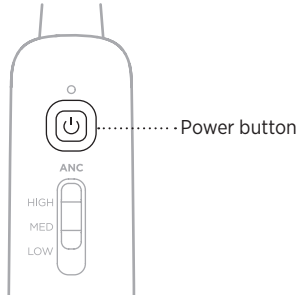

The Power light glows amber then blinks according to the power level.
See “Power light” on page 33.

NOTE: The first time you power on your headset, noise cancellation is fully enabled.
See “Acoustic Noise Cancellation” on page 21.

POWER OFF

Press and hold  for three seconds, then release.

When powered off, the headset provides passive audio communications.



Acoustic Noise Cancellation reduces unwanted noise providing a clearer, more lifelike audio performance. You can choose your noise cancellation based on your listening preferences and environment.

NOTE: When you receive a call, the headset remains at the current noise cancellation level.

ACOUSTIC NOISE CANCELLING FUNCTIONS

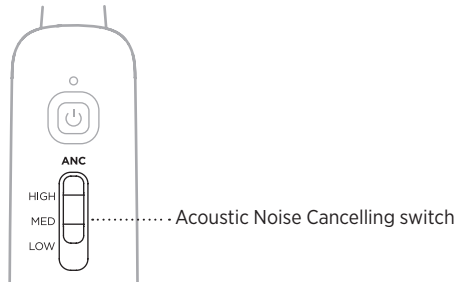
The Acoustic Noise Cancelling switch is located on the front of the control module.



| FUNCTION | POSITION | DESCRIPTION |
|---------------|---|---|
| High |  <p>HIGH MED LOW</p> | Maximum quiet and noise cancellation across the entire spectrum. Best signal-to-noise ratio for radio and intercom communications in loud aircraft. |
| Medium |  <p>HIGH MED LOW</p> | Consistent noise reduction across a wide range of frequencies. Best for clear and comfortable noise cancellation in typical jet aircraft. |
| Low |  <p>HIGH MED LOW</p> | Best for improved interpersonal communication outside of the intercom. |

TAP CONTROL FOR TALK-THROUGH COMMUNICATION

When you need to focus on interpersonal communication coming from a specific direction, you can automatically set noise cancelling to Low on a single earbud by firmly double-tapping the earbud.

NOTES:

- By default, Tap Control is set to Off.
 - Tap Control is available only when the Acoustic Noise Cancelling switch is in the High or Medium position.
1. Make sure the Acoustic Noise Cancelling switch is in the High or Medium position.



2. Set the Tap Control switch to On.
See “Change the operation switches” on page 24.

ON - OFF TAP CONTROL



3. Firmly double-tap the earbud.

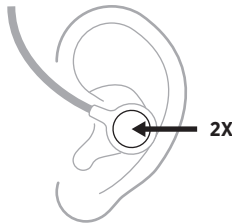

NOTE: Tap Control is not a touch control feature. You must firmly double-tap the earbud in order to activate the feature.

Reset Tap Control





To reset Tap Control and set noise cancelling in both earbuds to the Acoustic Noise Cancelling switch level, double-tap the earbud with Tap Control active or move the switch to another position.

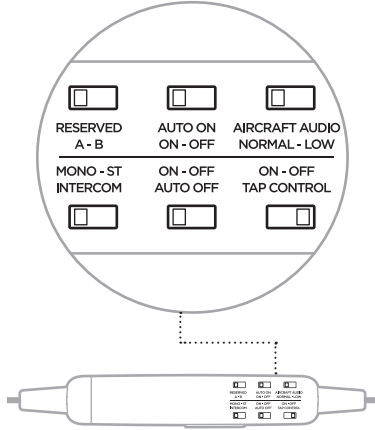

OPERATION SWITCH FUNCTIONS

The operation switches are located in the control module battery compartment.

NOTE: Some operation switches are not available on all models.



| FUNCTION | POSITION | DEFAULT | DESCRIPTION |
|-----------------------|---|---------|--|
| Reserved |  RESERVED A - B | A | Reserved for future use. |
| Auto on |  AUTO ON ON - OFF | On | Power on automatically when connected to aircraft power. NOTES: <ul style="list-style-type: none"> Available in Flex power models only (see page 30). <i>Bluetooth</i> headsets return to the previous <i>Bluetooth</i> state when powered on. |
| Aircraft audio |  AIRCRAFT AUDIO NORMAL - LOW | Normal | Set sensitivity/volume of intercom audio. NOTE: Low is -8dB. |
| Intercom | MONO - ST INTERCOM  | Mono | Process audio as mono or stereo. Available for configurations that support two-channel or stereo intercom systems only. |

| FUNCTION | POSITION | DEFAULT | DESCRIPTION |
|--------------------|--|---------|---|
| Auto off | ON - OFF AUTO OFF  | On | Power off automatically after 3 to 45 minutes of inactivity. NOTES: <ul style="list-style-type: none"> • When running on battery power and unplugged from the intercom, the headset powers off unless there is an active mobile device audio present. • If you are on a call and unplugged from the intercom, the headset powers off approximately three minutes after the call is ended. |
| Tap control | ON - OFF TAP CONTROL  | Off | Don't respond to Tap Control interaction (see page 22). |

CHANGE THE OPERATION SWITCHES

1. Power off the headset. See page 20.
2. On the back of the control module, press down firmly on the finger indent and slide the cover down.

CAUTION: The battery cover is tethered to the control module. Do NOT attempt to detach it.



3. Remove the batteries.
4. Using a pen or a small, flat-tipped screwdriver, gently move the switch.

5. Insert two alkaline AA batteries, observing proper polarity.

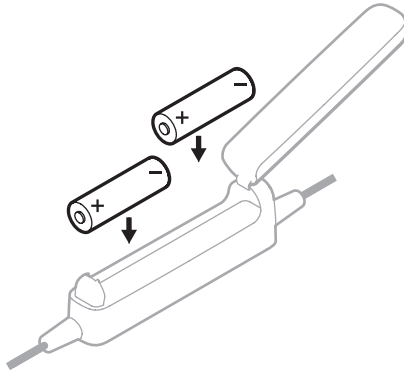

CAUTION: If the batteries don't fit correctly, do NOT force them in. Forcing an improper connection will cause permanent damage to the control module.

6. Close the battery cover, press firmly down on the finger indent, and slide the cover into place.

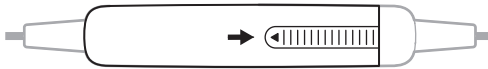

By default, the reversible microphone assembly ships from the factory attached to the left side of the headset, however, in some configurations it may ship separately. It can be easily attached to the left or right side of the headset.

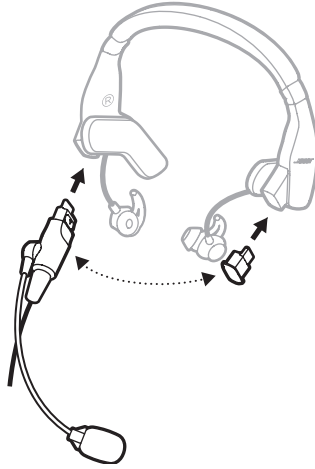

MOVE THE MICROPHONE

To move the microphone assembly from the left side of the headset to the right side:

1. Locate the left Ⓛ and right Ⓡ icons on the headband to orient the headset properly.
2. On the left side, rotate the side pad.

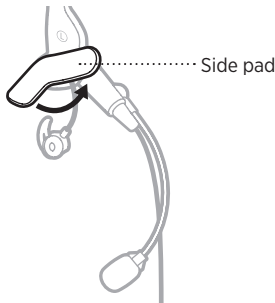

3. Push the release button, and gently pull the microphone assembly from the connector socket.

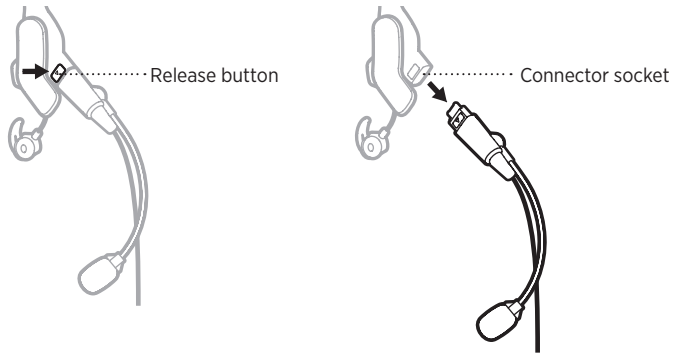

4. On the right side, push the release button, and gently pull the terminator cover from the connector socket.



5. On the left side, align the release button to the release button opening, and insert the terminator cover into the base of the connector socket.

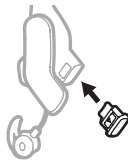

6. Slide the terminator cover into the connector socket until the release button is secure.

CAUTION: Do NOT force the terminator cover into the connector socket.

NOTE: If the terminator cover is not securely installed, there will be no audio coming from that earbud.

7. On the right side, align the release button to the release button opening, and insert the microphone connector into the base of the connector socket.

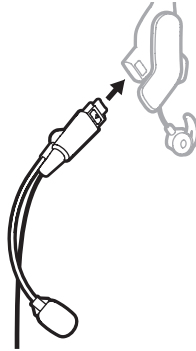

8. Slide the microphone connector into the connector socket until the release button is secure.

CAUTION: Do NOT force the microphone connector into the connector socket.

9. Test the headset before flight.

REPLACE THE BATTERIES

When the battery light blinks red, the batteries must be replaced.

NOTE: For aircraft-powered headsets, batteries are not required for operation if aircraft power is available. See “Aircraft Connectors” on page 30.

1. Power off the headset. See page 20.
2. On the back of the control module, press down firmly on the finger indent and slide the cover down.

CAUTION: The battery cover is tethered to the control module. Do NOT attempt to detach it.

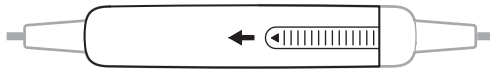

3. Remove the batteries.
4. Insert two alkaline AA batteries, observing proper polarity.

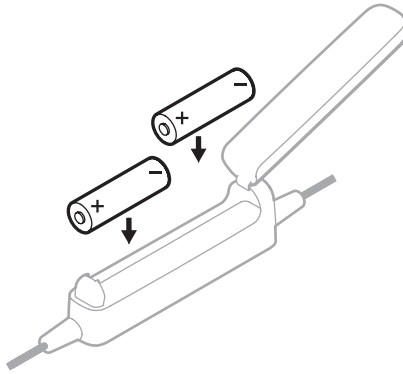

CAUTION: If the batteries don't fit correctly, do NOT force them in. Forcing an improper connection will cause permanent damage to the control module.

5. Close the battery cover, press firmly down on the finger indent, and slide the cover into place.



New alkaline AA batteries supply up to 45 hours of power for the headset. Battery life varies with the ambient noise level of the aircraft, temperature, ear tip condition, *Bluetooth* use, and age of the batteries.

Aircraft connectors are available in several standard aircraft connector options.

| POWER TYPE | CONNECTOR OPTIONS |
|---|---|
| Battery power only. | Dual plug (general aviation) |
| <p>Flex Power - Aircraft power or battery power. No battery needed when connected to aircraft power.</p> <p>NOTE: This version is often called Flex powered and comes with an Auto On function (see page 23).</p> | <p>5-pin XLR 6-pin Lemo 7-pin XLR</p> <p>NOTES:</p> <ul style="list-style-type: none"> • An adapter is available to convert a 6-pin Lemo connector to a Dual plug for additional connection flexibility. • Not all aircraft provide power to multi-pin connectors. Check the power status to confirm power is supplied to the headset (see page 33). |

NOTE: Contact Bose customer service for more information about these connectors.

DUAL PLUG

The battery (only) powered version of the headset has two general aviation aircraft connectors that insert into specific jacks on the aircraft control panel. The microphone connector is shorter, thinner and has a slightly different shape than the intercom connector.

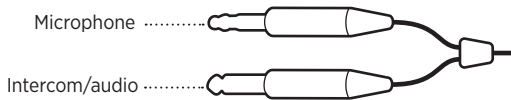

Connect to the aircraft

1. Insert the thicker intercom connector into the audio jack on the aircraft control panel.
2. Insert the thinner microphone connector into the microphone jack on the aircraft control panel.

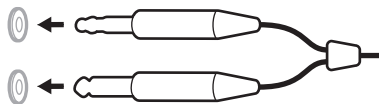

Disconnect from the aircraft

Gently pull back on each connector to remove the connector from the aircraft control panel.

5-PIN XLR, 6-PIN LEMO, AND 7-PIN XLR

The 5-pin XLR, 6-pin Lemo, and 7-pin XLR aircraft connectors insert into the aircraft control panel and provide the headset with aircraft power and intercom audio.

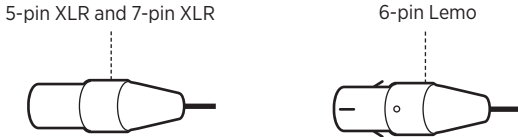

Connect to the aircraft

1. Align the connector to the connector keyway by matching the narrow bar on the connector to the slot on the connector.
2. Firmly insert the connector into the connector jack on the aircraft control panel.

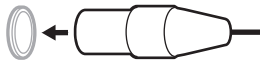

Disconnect from the aircraft

5-pin XLR and 7-pin XLR

1. Press the button/latch on the aircraft control panel to release the connector, if necessary.
2. Gently pull back to remove the connector from the aircraft control panel.

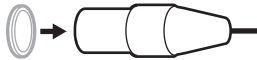

6-pin Lemo

1. Pull back on the sleeve near the end of the connector.

CAUTION: You must pull back on the sleeve before you pull out the connector. Forcing the connector out will damage the cable and/or the aircraft control panel.

2. Continue gently pulling back to remove the connector from the aircraft control panel.

The *Bluetooth* and Power lights are located on the front of the control module.

BLUETOOTH LIGHT

NOTE: This section applies to *Bluetooth* headsets only.

Shows the connection status of a mobile device.

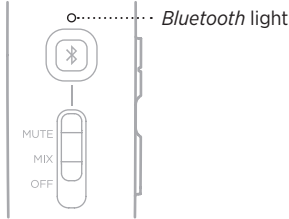

| LIGHT ACTIVITY | SYSTEM STATE |
|---|------------------|
| Blinking purple (in sync with Power light) | Ready to connect |
| Blinking blue (alternating with Power light) | Connecting |
| Blinking blue (in sync with Power light) | Connected |

NOTE: To dim the *Bluetooth* and Power lights, double-press .

POWER LIGHT

Shows the power source and level.

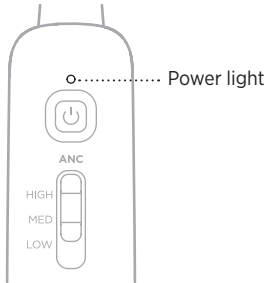

| POWER SOURCE | LIGHT ACTIVITY | SYSTEM STATE |
|---------------------|---------------------|---|
| Aircraft | Slow blinking green | Power On |
| Battery | Blinking green | Power On—batteries high (8 hours or more) |
| Battery | Blinking amber | Power On—batteries low (2 to 8 hours remaining) |
| Battery | Blinking red | Power On—batteries low (2 hours or less remaining) NOTE: In <i>Bluetooth</i> headsets, when the batteries reach this level, the <i>Bluetooth</i> feature is disabled to conserve remaining power. You hear a tone, indicating that your <i>Bluetooth</i> device is disconnecting and the <i>Bluetooth</i> feature is turning off. |
| Aircraft or battery | None | Power Off or batteries depleted |

NOTE: To dim the Power and *Bluetooth* lights, double-press .

New alkaline AA batteries supply up to 45 hours of power for the headset. Battery life varies with the ambient noise level of the aircraft, temperature, ear tip condition, *Bluetooth* use, and age of the batteries.

Bluetooth wireless technology lets you stream audio from mobile devices such as smartphones, tablets, and laptop computers. Before you can stream audio from a device, you must connect the device with your headset.

NOTE: This section applies to *Bluetooth* headsets only.

CONNECT USING THE *BLUETOOTH* MENU ON YOUR MOBILE DEVICE

1. Make sure the *Bluetooth* priority switch is in the Mute or Mix position. See “*Bluetooth* audio priority” on page 35.

NOTE: If the *Bluetooth* priority switch is set to Off, *Bluetooth* is disabled.

2. Press and hold the *Bluetooth*/Multi-function button $\&$ for one second.
The *Bluetooth* light blinks purple.

3. On your mobile device, enable the *Bluetooth* feature.

TIP: The *Bluetooth* feature is usually found in the Settings menu.

4. Select the headset from the device list.

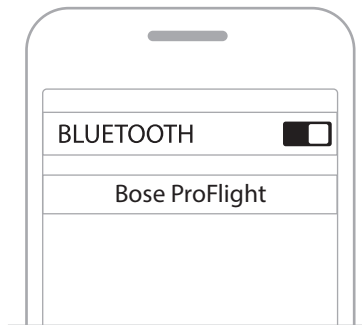

Once connected you hear a tone, and the *Bluetooth* light blinks blue.

NOTES:

- After 5 minutes of inactivity, the headset automatically exits pairing mode, and the *Bluetooth* light turns off. To turn the *Bluetooth* feature back on, press $\&$.
- Each time you turn on the *Bluetooth* feature, the headset attempts to reconnect with the two most recently connected *Bluetooth* devices. If the device(s) are turned off or out of range, the headset returns to pairing mode after 5 minutes. See “Reconnect a mobile device” on page 37.

CONNECT YOUR MOBILE DEVICE USING THE BOSE CONNECT APP

Download the Bose Connect app, and follow the on-screen connection instructions.

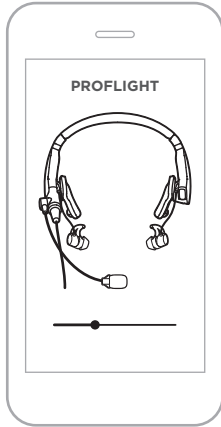

Once connected you hear a tone, and the *Bluetooth* light blinks blue.



BLUETOOTH AUDIO PRIORITY

The aircraft intercom system (ICS) is always the headset's primary audio source. When the headset is plugged in to the aircraft, intercom signals are always heard and cannot be muted by the headset. You can configure how you hear the device audio with the intercom.

NOTE: *Bluetooth* audio will never override the intercom.

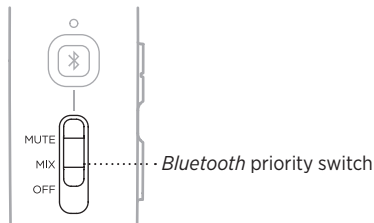
The *Bluetooth* priority switch is located on the front of the control module.



| FUNCTION | POSITION | DESCRIPTION |
|-------------|---|--|
| Mute |  <p>MUTE MIX OFF</p> | <p>When an intercom signal is detected, <i>Bluetooth</i> audio is temporarily muted until intercom audio ceases.</p> |
| Mix |  <p>MUTE MIX OFF</p> | <p>When an intercom signal is detected, <i>Bluetooth</i> audio is mixed with intercom audio.</p> <p>You hear a maximum of two audio sources; the intercom plus 1 <i>Bluetooth</i> device.</p> |
| Off |  <p>MUTE MIX OFF</p> | <p>Only intercom audio is active. <i>Bluetooth</i> functionality is disabled.</p> <p>NOTES:</p> <ul style="list-style-type: none"> • All <i>Bluetooth</i> connections are disabled and antennae power is removed. • If you switch to OFF while connected to a <i>Bluetooth</i> device, you may need to re-establish your <i>Bluetooth</i> connection the next time you turn on the headset. |

NOTES:

- When Mute or Mix are selected, incoming and outgoing phone calls automatically mute all other secondary audio sources.
- During a phone call, the intercom and the phone call are heard as mixed.

DISCONNECT A MOBILE DEVICE

Press and hold the *Bluetooth*/Multi-function button \times for five seconds to turn the *Bluetooth* feature off.

Move the *Bluetooth* priority switch to the Off position.

Use the Bose Connect app to disconnect your mobile device.

TIP: You can also use *Bluetooth* settings to disconnect your device. Disabling the *Bluetooth* feature disconnects all other devices.

RECONNECT A MOBILE DEVICE

When powered on, the headset tries to reconnect with the two most recently-connected devices.

NOTE: The devices must be within range (30 ft. or 9 m) and powered on.

RECOVER A LOST CONNECTION

When your connected mobile device moves out of range, the connection is lost. The headset automatically attempts to reconnect. If the headset is unable to reconnect, it returns to pairing mode. After five minutes of inactivity, the *Bluetooth* feature turns off.

1. Move the device back into range.
2. Press the *Bluetooth*/Multi-function button  to reconnect.

You can pair additional devices to your headset. These *Bluetooth* connections are controlled with the *Bluetooth*/Multi-function button \mathbb{X} . Before connecting an additional mobile device, make sure this feature is enabled.

TIP: You can also easily manage multiple connected devices using the Bose Connect app.

NOTE: This section applies to *Bluetooth* headsets only.

CONNECT AN ADDITIONAL MOBILE DEVICE

You can store up to eight paired devices in the headset pairing list, and your headset can be actively connected to two devices at a time.

To connect an additional device, use the *Bluetooth* menu on your device or download the Bose Connect app.

NOTES:

- Only one device can be heard at a time.
- *Bluetooth* audio will never override the intercom.

SWITCH BETWEEN CONNECTED DEVICES

1. Pause audio on your first device.
2. Play audio on your second device.

CLEAR THE HEADSET PAIRING LIST

1. Press and hold \mathbb{X} and — simultaneously for seven seconds, or until the *Bluetooth* light blinks purple in sync with the Power light.
2. Delete the headset from the *Bluetooth* list on your device.

All devices are cleared, and the headset is ready to connect. See “*Bluetooth* Connections” on page 34.

NOTE: This section applies to *Bluetooth* headsets only.

BLUETOOTH VOLUME FUNCTIONS

The *Bluetooth* volume controls are located on the side of the control module.

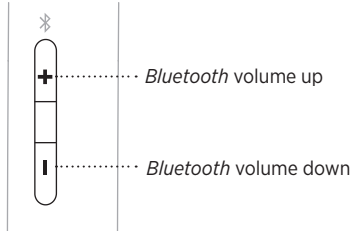

| FUNCTION | WHAT TO DO |
|------------------------------|------------|
| Bluetooth volume up | Press +. |
| Bluetooth volume down | Press -. |

CALL FUNCTIONS

The *Bluetooth*/Multi-function button \mathbb{B} is located on the front of the control module.

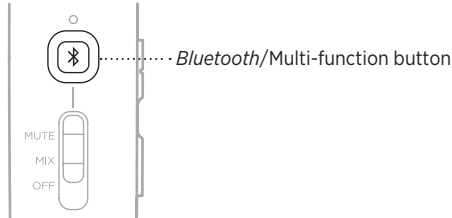

| FUNCTION | WHAT TO DO |
|----------------------|---|
| Make a call | Dial from your connected phone. The call automatically transfers to the headset. |
| Answer a call | Press \mathbb{B} . You hear a short beep before you hear the incoming call. |
| End a call | Press \mathbb{B} . You hear two short beeps indicating the call has ended. |

| FUNCTION | WHAT TO DO |
|---|---|
| Decline an incoming call | Press and hold \mathbb{X} for one second. You hear two short beeps indicating the call has been declined. |
| Answer a second incoming call and put the current call on hold | While on a call, press the <i>Bluetooth</i> /Multi-function button \mathbb{X} . You hear a short beep before you hear the second call. |
| Decline a second incoming call and stay on current call | While on a call, press and hold \mathbb{X} for one second. You hear two short beeps indicating the call has been declined. |
| Switch between two calls | With two active calls, double-press \mathbb{X} . You hear a short beep before you hear the incoming call. |
| Redial the last number | When there are no active or incoming calls, double-press \mathbb{X} . |
| Transfer audio to the mobile device | While on a call, press and hold \mathbb{X} for three to four seconds. The audio is transferred to the mobile phone while the <i>Bluetooth</i> connection remains active. |
| Activate voice control | When there are no active or incoming calls, press \mathbb{X} . |
| Mute/unmute a call | While on a call, press + and – simultaneously. You hear two short beeps indicating the call has been muted/unmuted. |

NOTES:

- If you are on a call and unplugged from the intercom, the headset powers off approximately three minutes after the call is ended.
- To use the headset when unplugged from the intercom (to listen to audio or to make or receive calls), Bose recommends to disable the Auto Off feature for uninterrupted functionality. See “Operation Switches” on page 23.
- Some functions may not be available for some mobile devices. Refer to your device owner’s guide for more information.

STORE THE HEADSET

- Place the headset in the carry case for easy, convenient storage.
- Store the headset in a ventilated area away from direct sunlight.
- Remove the batteries before storing the headset for extended periods.

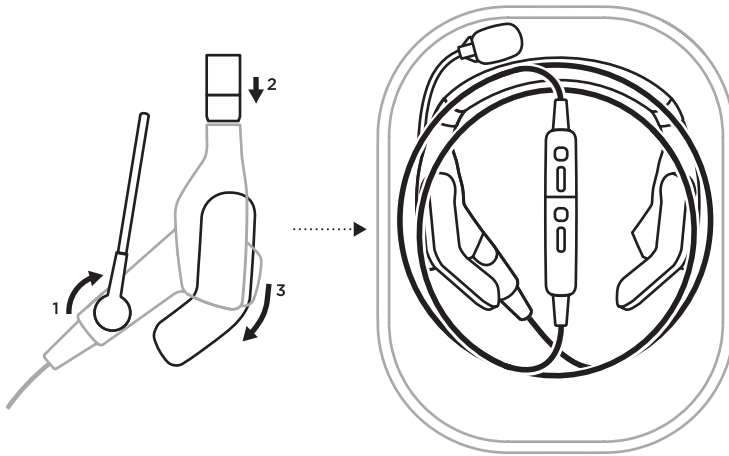

1. Rotate the microphone up to the headband.
2. Adjust the headband.
3. Rotate the side pads.
4. Place the headset in the case.
5. Wrap the control module cable around the perimeter of the case.
6. Place the control module in the center of the headband.
7. Wrap the remaining cable around the perimeter of the case.

NOTE: Attach the carry case clip to hang the case in the aircraft.



CLEAN THE HEADSET

Your headset may require periodic cleaning.

| COMPONENT | CLEANING PROCEDURE |
|------------------------------|--|
| Headset | Wipe the outside surfaces of the headband, headband cushion, side pads, connectors, and plastic parts using a soft, damp cloth (water only) and mild soap. CAUTION: Do NOT immerse the headset in water or any liquid. |
| StayHear+ tips | <ol style="list-style-type: none"> 1. Remove the StayHear+ tips from the earbuds and wash them with a mild soap and water. 2. Once the StayHear+ tips are completely dry, re-attach them to the earbuds. |
| Microphone windscreen | <ol style="list-style-type: none"> 1. Gently slide or roll the windscreen off the microphone. 2. Rinse and dry the windscreen. 3. Once the windscreen is completely dry, slide the windscreen back on the microphone. 4. Make sure it fits completely over the microphone. |

LIMITED WARRANTY

The headset is covered by a limited warranty. Details of the limited warranty are provided on the product registration card that is in the carton. Please refer to the card for instructions on how to register. Failure to do so will not affect your limited warranty rights.

1. Contact the Bose organization in your country/region (visit [global.Bose.com](https://www.bose.com) for Bose contact information in your country/region) for specific return and shipping instructions.
2. Label and ship the product, freight prepaid, to the address provided by the Bose organization in your country.
3. Place any necessary return authorization number prominently on the outside of the carton. Cartons not bearing a return authorization number, where required, will be refused.

SERIAL NUMBER LOCATION

The serial number is located on the side pad. To view the serial number, gently grab and peel the side pad cushion from the left edge away from the side pad.

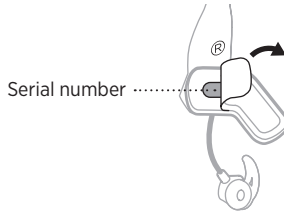

Refer to this serial number when you register your product or contact Bose for technical support.

REPLACEMENT PARTS AND ACCESSORIES

Through normal use, parts like windscreens and ear tips may require periodic replacement. Replacement parts and accessories can be ordered through Bose customer service.

Visit: worldwide.Bose.com/Support/ProFlight2

Side pad cushion

1. Gently grab and peel the side pad cushion away from the side pad.



2. Align the new side pad cushion to the side pad.

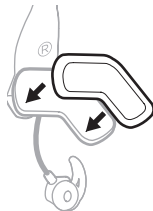

3. Press the Velcro to secure the side pad cushion in place.

Headband cushion

Replace the cushion after regular care and maintenance fails to restore the cushion to its original size and shape.

1. Gently grab and peel the headband cushion away from the headband.

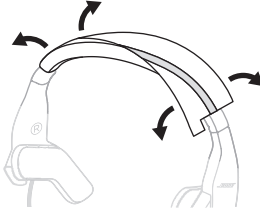

2. Place the new headband cushion under the headband with adhesive facing rear.

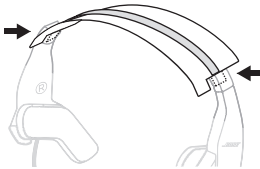

3. Fold the adhesive flap over the headband.

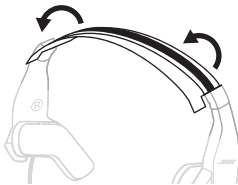

4. Peel away the adhesive backing, fold top flap, and adhere the top to the adhesive.

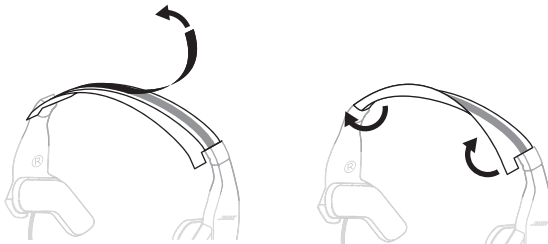

5. Insert the left and right tabs into the plastic cap.

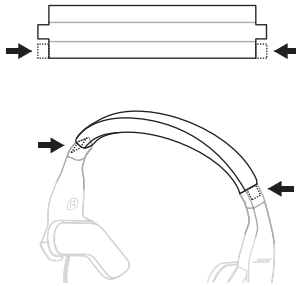

StayHear+ tips

Replace tips every six months or every 350 hours of use, depending on how often you fly. See “Change the StayHear+ tips” on page 17. You may have to replace them more often, if you:

- Subject the headset to severe temperature extremes such as parking your airplane outside in severe cold or heat.
- Put excess strain on the tips because of improper storage.

To extend the life of the StayHear+ tips, clean them regularly. See “Clean the headset” on page 42.

Microphone windscreen

1. Gently grab the microphone base and peel the windscreen away from the microphone.



2. Slide the windscreen off the microphone.

- Slide the new windscreen on the microphone.



- Make sure it fits completely over the microphone.
- Press the sides of the windscreen to secure into place.

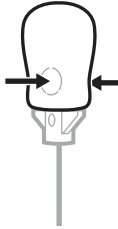

Batteries

See “Batteries” on page 29.

Microphone or terminator cover

See “Microphone Placement” on page 26.

TRY THESE FIRST

If you experience problems with your headset, try these solutions first:

- Power on the headset (see page 20).
- Check the state of the status lights (see page 32).
- Make sure the earbud is fully inserted and securely sealed (see page 16).
- For *Bluetooth* headsets:
 - Make sure your mobile device supports *Bluetooth* (see page 34) 2.1 and greater.
 - Increase the volume on your *Bluetooth* device (see page 39) and audio or music app.
 - Try connecting another *Bluetooth* device (see page 38).

OTHER SOLUTIONS

If you could not resolve your issue, see the table below to identify symptoms and solutions to common problems. If you are unable to resolve your issue, contact Bose customer service.

Visit: worldwide.Bose.com/contact

Acoustic Noise Cancelling

| PROBLEM | WHAT TO DO |
|--|---|
| <p>Communication, but no noise cancellation in either ear</p> | <p>If using aircraft power, check the aircraft fuse or circuit breaker.</p> <p>If using battery power, make sure the batteries are fresh and correctly installed. See “Batteries” on page 29.</p> <p>If using aircraft power, make sure the connector is firmly seated in the control panel and the control panel has power. See “Aircraft Connectors” on page 30.</p> <p>Power off, then power on the headset. See “Headset Controls” on page 20.</p> <p>NOTE: Don't press the Power button  repeatedly.</p> |

| PROBLEM | WHAT TO DO |
|--|---|
| No active noise cancellation and no communication | <p>If using battery power, make sure the batteries are fresh and correctly installed. See “Batteries” on page 29.</p> <p>If using aircraft power, make sure the connector is firmly seated in the control panel and the control panel has power. See “Aircraft Connectors” on page 30.</p> <p>Power off, then power on the headset. See “Headset Controls” on page 20.</p> <p>NOTE: Don’t press the Power button  repeatedly.</p> <p>Use the headset in a different seat location.</p> <p>Remove microphone assembly from the headset, and check for damage to the connector or pins. See “Move the microphone” on page 26.</p> |

Intercom communications

| PROBLEM | WHAT TO DO |
|---|---|
| Noise cancellation active, but no incoming audio | <p>Make sure the volume controls are not set too low on the control module (see page 39) or the intercom.</p> <p>Make sure the aircraft connectors are securely inserted into the aircraft control panel. See “Aircraft Connectors” on page 30.</p> <p>Use a different seat location in the aircraft.</p> |
| Low volume of incoming communications | <p>Make sure the volume controls are not set too low on the control module (see page 39) or the intercom.</p> <p>Make sure the Intercom operation switch is correctly set for your intercom system. See “Operation Switches” on page 23.</p> <p>Make sure all headsets sharing the intercom have the Intercom operation switch in the correct position. See “Operation Switches” on page 23.</p> <p>Unplug all other headsets and see if the volume can be adjusted to an acceptable level.</p> |
| Intermittent communication | <p>Make sure the aircraft connectors are securely inserted into the aircraft control panel. See “Aircraft Connectors” on page 30.</p> <p>Use a different seat location in the aircraft.</p> |
| Reduced volume in one ear only | <p>Make sure the volume controls are not set too low on the control module (see page 39) or the intercom.</p> <p>Make sure the Intercom operation switch is correctly set for your intercom system. See “Operation Switches” on page 23.</p> |

| PROBLEM | WHAT TO DO |
|---|--|
| No stereo separation or communications in one ear only | <p>Make sure the Intercom operation switch is correctly set for your intercom system. See “Operation Switches” on page 23.</p> <p>Make sure the terminator cover is securely installed. See “Move the microphone” on page 26.</p> <p>Depending on how your audio jacks are wired, there may be only one channel of audio supplied to the headphone jack. If the Intercom (MON-ST) operation switch is set to ST and you only hear communications on one side, set the operation switch to MON to play audio on both sides. 5-pin XLR models are mono audio only.</p> |

Audio

| PROBLEM | WHAT TO DO |
|--|--|
| Reduced noise cancellation, intermittent clicking sounds, or communication distortion in a loud environment | <p>Make sure the StayHear+ tips are clean and free of debris. See “Clean the headset” on page 42.</p> <p>Remove the microphone, then attach again. See “Move the microphone” on page 26.</p> <p>If the headset emits any loud noise and related loss of communications while in the Acoustic Noise Cancelling mode, turn the power off. The headset will continue to provide communications in the passive noise reducing mode.</p> |
| Squealing or whistling sound when the headset powers on | <p>Make sure the headset orientation is correct. Use the Left Ⓕ and Right Ⓖ markings on the headset to orient the headset correctly.</p> <p>Make sure the StayHear+ tips are firmly seated on the earbuds.</p> <p>Make sure the earbuds are fully seated in your ears. See “Fit the earbuds to your ear” on page 16.</p> <p>Make sure the proper sized StayHear+ tips are being used. See “Choose the correct StayHear+ tips” on page 16.</p> <p>Make sure the earbud openings are clean and free of debris.</p> |
| Low rumbling sound with the headset turned on in a quiet environment | <p>Make sure the earbuds fit correctly. See “Choose the correct StayHear+ tips” on page 16.</p> <p>Make sure the StayHear+ tips are clean and free of debris. See “Clean the headset” on page 42.</p> |

| PROBLEM | WHAT TO DO |
|--|--|
| Crackling sound audible with headset turned on in a loud environment, or noise cancelling is intermittent | <p>Make sure the headset orientation is correct. Use the Left Ⓛ and Right Ⓡ markings on the earbuds to orient the headset correctly.</p> <p>Make sure the earbuds fit correctly. See “Choose the correct StayHear+ tips” on page 16.</p> <p>Make sure the StayHear+ tips are clean and free of debris. See “Clean the headset” on page 42.</p> <p>Remove the microphone, then attach again. See “Move the microphone” on page 26.</p> <p>If using battery power, check if the battery is low. See “Power light” on page 33.</p> <p>If using aircraft power, make sure the voltage powering the headset is no less than 10 VDC.</p> |

WARNING: If the headset emits any loud noise and related loss of communications while in the Acoustic Noise Cancelling mode, turn the power off. The headset will continue to provide communications in the passive noise reducing mode.

Microphone

| PROBLEM | WHAT TO DO |
|-----------------------------------|--|
| No sound to the microphone | <p>Make sure the white surface on the microphone is facing your mouth. See “Adjust the microphone” on page 18.</p> <p>Make sure the microphone is fully connected to the headband. See “Microphone Placement” on page 26.</p> <p>Check the Squelch level on the intercom. The Squelch level may need to be adjusted.</p> <p>Try another intercom position in the aircraft.</p> <p>For <i>Bluetooth</i> phone calls, make sure the batteries are fresh and correctly installed. See “Batteries” on page 29.</p> <p>NOTE: For <i>Bluetooth</i> headsets only.</p> |

Bluetooth audio source

NOTE: This section applies to *Bluetooth* headsets only.

| PROBLEM | WHAT TO DO |
|---|--|
| <p>No audio from the Bluetooth source to the headset while on a call</p> | <p>Make sure the <i>Bluetooth</i> priority switch is in the Mute or Mix position. See “<i>Bluetooth</i> audio priority” on page 35.</p> <p>Turn on and off <i>Bluetooth</i> on the mobile device. See “Connect using the <i>Bluetooth</i> menu on your mobile device” on page 34.</p> <p>Make sure the <i>Bluetooth</i> feature is on, and the <i>Bluetooth</i> light is flashing. See “<i>Bluetooth</i> light” on page 32.</p> <p>Make sure the headset and device are in range (30 ft. or 9 m).</p> <p>Make sure the mobile device is connected properly and the headset is ready to pair. See “<i>Bluetooth</i> Connections” on page 34.</p> <p>Make sure the <i>Bluetooth</i> volume is not set too low on the control module. See “<i>Bluetooth</i> volume functions” on page 39.</p> |
| <p>Headset does not pair with a device</p> | <p>Turn on and off <i>Bluetooth</i> on the mobile device.</p> <p>Make sure the <i>Bluetooth</i> feature is on, and the <i>Bluetooth</i> light is flashing. See “<i>Bluetooth</i> light” on page 32.</p> <p>Make sure the <i>Bluetooth</i> priority switch is in the Mute or Mix position. See “<i>Bluetooth</i> audio priority” on page 35.</p> <p>Clear the headset pairing list (see page 38) and connect again.</p> <p>Delete the headset from your device’s <i>Bluetooth</i> device list and pair again.</p> |
| <p>Cannot answer/end a call</p> | <p>Make sure your mobile device is connected to the headset.</p> <p>Turn your device off and on. Connect again.</p> |
| <p>Headset does not reconnect to a previously connected device</p> | <p>Make sure the headset and device are in range (30 ft. or 9 m).</p> <p>Make sure the <i>Bluetooth</i> priority switch is in the Mute or Mix position. See “<i>Bluetooth</i> audio priority” on page 35.</p> <p>Make sure the <i>Bluetooth</i> feature is on, and the <i>Bluetooth</i> light is flashing. See “<i>Bluetooth</i> light” on page 32.</p> <p>On your mobile device, make sure the <i>Bluetooth</i> feature is on.</p> <p>Delete the headset from your device’s <i>Bluetooth</i> device list and pair again.</p> |

Auto on/off

NOTE: This function is not available for Dual plug connectors.

| PROBLEM | WHAT TO DO |
|--|---|
| <p>Headset does not power on automatically</p> | <p>Make sure the Auto on operation switch is set to ON. See “Operation Switches” on page 23.</p> <p>Check the aircraft specifications to see if the jack is getting power from the aircraft’s electrical system.</p> |
| <p>Headset does not power off automatically</p> | <p>Make sure the Auto off operation switch is set to ON. See “Operation Switches” on page 23.</p> <p>Disconnect the headset from the aircraft. Then power on the headset and wait 15 minutes.</p> <p>It may take up to 9 minutes for the headset to power off when not in use immediately after initial power up. If the headset has not powered off after 15 minutes, contact Bose customer service.</p> |

MOUNT THE AIRCRAFT PANEL CONNECTOR

The aircraft panel connector is part of the optional 6-pin wiring harness assembly.

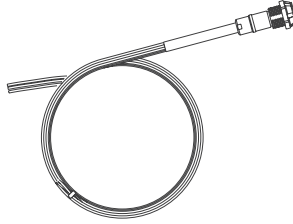

Visit www.Bose.com or global.Bose.com for information or purchase.

WARNING: The aircraft panel connector must be mounted by a technician who is qualified to perform this type of avionics installation for the aircraft you are using.

Mount the connector into a cutout, using the diagrams below as a guide.

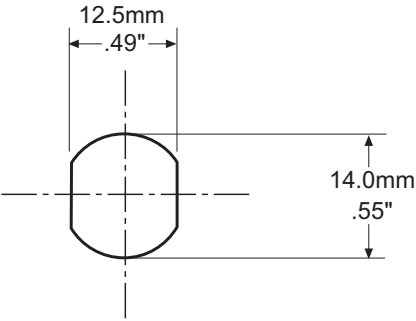

Receptacle - Pinout (front view)

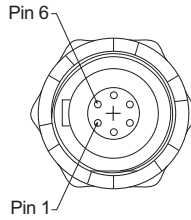

Aircraft Interface Schematic

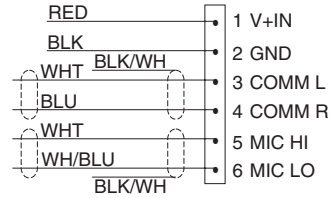

Connect the eight wires as follows:

- Two for the microphone
- Two for audio
- One for power
- One for ground
- Two for audio shields

Audio and microphone wires should be connected to the back of the existing microphone and headphone jacks, leaving existing jacks intact for use with conventional headsets. This is usually the fastest installation method.

CAUTION: Do NOT use excessive force or bend the installed connector. This may damage or break internal solder joints.

NOTE: The aircraft panel connector cannot be installed in an audio system using transformer-coupled audio outputs. Contact Bose customer service.

Mono connection diagram

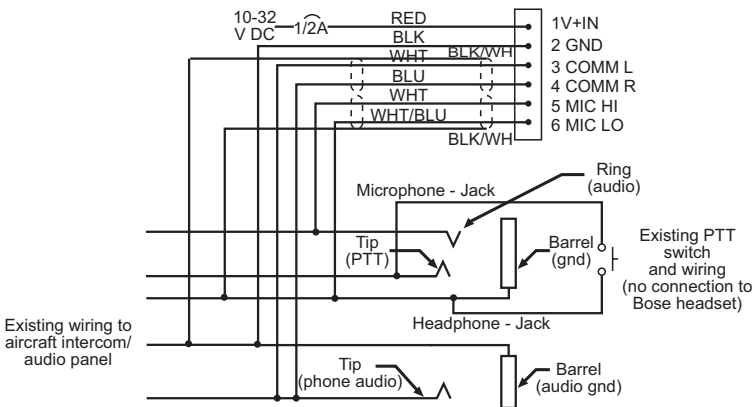

Stereo connection diagram

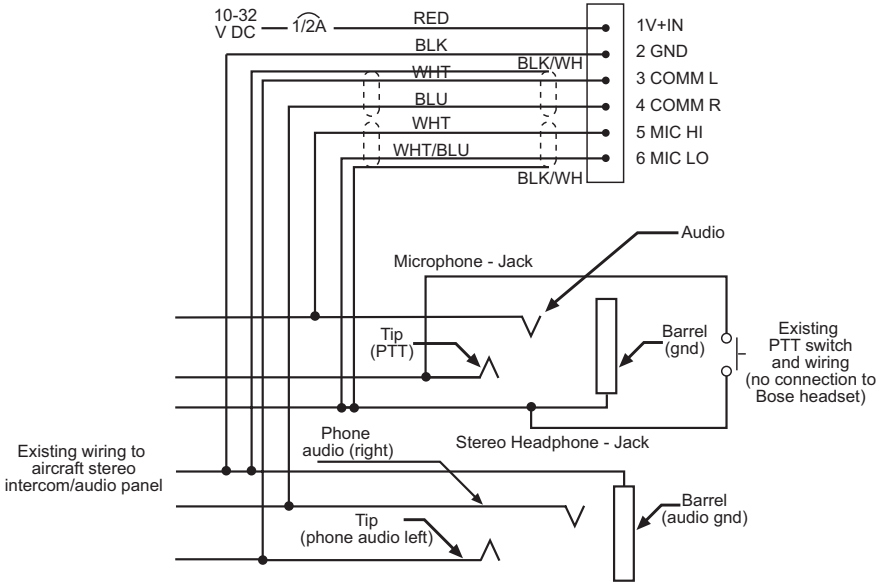

Details on making the connections

The pinouts for the optional installed connector are detailed in the table below.

| PIN NUMBER | COLOR | PURPOSE |
|--|------------|---|
| 1 | Red | V+IN: Headset power (10-32 VDC). Use a 1/4 amp fuse or a 1/2 amp circuit breaker. |
| 2 | Black | GND: System ground. Connect to the existing audio ground. |
| 3 | White | COMM L: Phone communication: Left. |
| 4 | Blue | COMM R: Phone communication: Right. |
| <p>NOTE: For stereo operation, connect the left and right channels to their respective positions. For monaural operation, connect pins 3 and 4 together, and to the tip of the existing phone jack.</p> | | |
| 5 | White | MIC HI: Microphone/Hi-audio. Connect to the portion of the existing microphone jack that corresponds to the ring position of a headset microphone plug. Don't connect to the tip (PTT) segment. |
| 6 | White/Blue | MIC LO: Microphone/Lo-ground. Connect to the portion of the microphone jack that corresponds to the barrel position of a headset microphone plug. |
| <p>NOTE: If the microphone works on radio transmit but not through the intercom, check pin 6. It may be incorrectly wired to the PTT segment of the microphone jack.</p> | | |
| Comm Shield | Black | Shield from Comm L and Comm R wire pair. |
| Mic Shield | Black | Shield from Mic Hi and Mic Lo wire pair. |
| <p>NOTE: The wires connecting pins 3 and 4 and pins 5 and 6 are shielded, twisted pairs with a black wire shield termination exiting each pair. If the existing wiring is not shielded, connect the shields to the existing audio wiring shields, or connect the shield from Comm L and Comm R wire pair to audio ground.</p> | | |

| SPECIFICATION | DESCRIPTION |
|-------------------------------------|---|
| Headphone sensitivity | 92dB SPL measure at 1 mW input signal, 1 kHz, in Mono mode |
| Headphone impedance | Mono mode: 150 Ohm ON and OFF Stereo mode: 300 Ohm ON and OFF |
| Headphone frequency response | RTCA-214a range: 300 to 3500Hz Extended range: 40Hz to 15kHz |
| Boom microphone sensitivity | -27dBV (+/- 2.5dB) at 94dB SPL (1 Pa), measured at 6mm distance from artificial mouth, across 220 Ohms load resistor and biased with 12 Vdc via 470 Ohms resistor. |
| Boom microphone bias | Operating bias voltage range: 4 to 28 VDC |
| Maximum ambient noise level | 105 dBC SPL for full active noise reduction performance |
| Battery power source | Two (2) AA alkaline batteries |
| Battery life | Up to 45 hours in typical commercial jet aircraft noise. Duration varies with battery age, ambient noise levels, temperature, ear tip condition, and use of the <i>Bluetooth</i> feature. |
| Aircraft power source | Aircraft power voltage range: 10 to 32 VDC |
| Average power consumption | 250mW |
| Fuse/breaker recommended | 1/4 amp, fast-blow fuse (AGC 1/4 amp fuse) or 1/2 amp circuit breaker |
| Headset weight | 9.6 ounces, 4.5 ounces on head |
| Headset size range | Slider not extended: 8.425" (214mm) H x 6.34" (161mm) W x 3.15" (80mm) D Slider extended: 10.2" (259mm) H x 6.6" (168mm) W x 3.15" (80mm) D |
| Control module dimensions | 1.5" (38.1mm) H x 1.5" (38.1mm) W x 4.92" (125mm) D |

| SPECIFICATION | DESCRIPTION |
|--|---|
| Temperature and Altitude (Category A) | Operating: 5 to 158°F (-15 to 70°C) Storage: -67 to 158°F (-55 to 70°C) Altitude: 15,000 feet maximum pressure altitude for full cancellation |
| Bluetooth wireless technology | 4.2 |
| Headset cable length | 6.56 ft. or 2 m |

FAA TECHNICAL STANDARD ORDER

The Bose ProFlight Series 2 Aviation Headset that is approved to TSO and ETSO C139a are appropriately marked. The product interface, cables, and microphones have been designed to function in or withstand exposure to the environmental conditions below.

This article meets the minimum performance and quality control standards required by a technical standard order (TSO). Installation of this article requires separate approval.

| CONDITION | CATEGORY |
|------------------------------------|---|
| Altitude and temperature | A2 |
| Salt fog | S |
| AF conducted susceptibility | B |
| Humidity | A |
| Magnetic effect | Z |
| Power input | B |
| RF Susceptibility | T |
| Vibration | R |
| Voltage spike | B |
| Shock drop | 12 times, 1 m onto concrete (per DO-214a) |
| Electrostatic discharge | A |

Environmental categories cited refer to RTCA/DO-160G and RTCA/DO-214a (December 18, 2013).

The conditions and tests required for TSO approval of this article are minimum performance standards. Those installing this article either on or within a specific type or class of aircraft must determine that the aircraft installation conditions are within the TSO standards which include any accepted integrated non-TSO functions. TSO articles and any accepted integrated non-TSO function(s) must have separate approval for installation in an aircraft. The article may be installed only according to 14 CFR part 43 or the applicable airworthiness requirements.

This device complies with FCC and Industry Canada RF radiation exposure limits for general population. It must not be collocated or operating in conjunction with any other antenna or transmitter.



838429-0010